

NEW PRODUCT: IV RANGE SALAD



GARCÍA ARREDONDO, IRENE
MASTER IN INTERNATIONAL
BUSINESS ADMINISTRATION
AND MODERN LANGUAGES
SEPTEMBER, 2013

TUTOR:
JAVIER MARTÍNEZ DEL RIO

INDEX

1. INTRODUCTION OF THE PROJECT	3
2. PRESENTATION OF THE COMPANY	6
3. REASONS FOR THE CHOICE OF THE PRODUCT	9
4. MARKETING STRATEGY	11
4.1. CONSUMPTION OF IV RANGE.....	11
4.2. USUAL CONSUMER PROFILE.....	12
4.3. SWOT ANALYSIS.....	13
4.4. COMPETITORS.....	14
4.5. COMPETITORS PRICES.....	18
4.6. POSITIONING STRATEGY.....	20
4.7. INSERTION STRATEGY	22
4.8. TARGET COUNTRIES	23
5. OPERATION STRATEGY	26
5.1. IV RANGE.....	26
5.2. PROCESS FLOW	27
5.3. IMPLEMENTATION DEVELOPMENT	31
5.3.1. MACHINERY.....	31
5.3.2. SURFACE	36
5.3.3. CONDITIONING OF THE PLANT.....	37
5.3.4. STAFF.....	38
5.3.5. CONTAINERS.....	39
6. ECONOMIC ANALYSIS.....	40
7. CONCLUSIONS.....	46
8. ANNEXES.....	49
9. LITERATURE	53

1. INTRODUCTION OF THE PROJECT

In the early stages of this project, when I had to decide about what develop it, I considered several initial ideas which would help me to consolidate all the knowledge offered by the Master finished. Finally, I chose the realization of a study about the insertion of a new product in the company S.A.T. 9989 Peregrín, specifically IV Range iceberg lettuce.

I chose this company because, nowadays I am doing my internship within the commercial department of it, where I am carrying out most of the tasks performed within the department. Some of these tasks are:



- Contacting with potential clients.
- Receiving orders and managing them for proper development.
- Continuous contact with customers in order to respond to any questions or needs they may have.
- Carrying out the billing tasks which take place in the sales department before reaching the administration.

This is allowing me to learn wide practical aspects of horticulture sector, which has a great relevance in Almeria province, and also about a company mainly engaged exporting and international trading. Those are the key aspects which make this project more profitable for the development of my career.

Another reason for my choice is that S.A.T. 9989 Peregrín is a dynamic, growing and broad prospect for the future. Without going any further, currently S.A.T. 9989 Peregrín is involved in a process of widespread growth through a significant investment by the owners thereof in order to increase efficiency and carrying out an expansion and modernization of facilities, all this has taken place since the previous facilities were becoming outdated and too narrow which did not allow to continue growing of the company to prevent the possibility of meeting and provide new

customers. This decision of the board of the company has been taken with a wide future vision and considering in medium term objective of insertion a series of new projects. Therefore, I considered the existence of an interesting opportunity to develop a project that is based on the launch of a new product.

When I start to investigate for the project, through online publications I had knowledge of the existence of an IV Range experimental plant within Tecnova facilities, owned by PITA (Parque Científico Técnico de Almería). I contacted them and they kindly offered me a visit to the processing plant where an expert explained to me the different stages, many others features and furthermore could physically see all the machinery. These contributions have been very valuable in the report completion.

After gathering all the necessary information I proceed to develop this document which conducts a study on the different aspects that must be taken into account with the aim of implement a project of this nature:

- First, there is a brief analysis of the company where there will be the introduction of the new product, describing the sector in which develop it business and some of its technical and commercial characteristics.
- Next, draw up the reasons why it considers that the IV Range iceberg lettuce is the most suitable product to be implemented within the expansion and growth company projects.
- Once these aspects have been studied, it dives into the marketing strategies where study areas such as the consumption of this project, habitual consumer characteristics, the competitors and different strategies that the company will apply to be successful.
- The project continues analyzing IV Range, where it will analyze exactly what it is and the different stages which the lettuce goes through to finally become a packaged product ready for consumption and all the technical features which must be considered for the installation of a processing line, taking into account from the required surface to the packaging to be used, through the description of machinery and design of the facilities.

- This document also has the purpose of discovering the viability and profitability of it and so that it performed an economic analysis. To do this we have used estimates data based on information provided by S.A.T. 9989 Peregrín, some suppliers, as well as official websites and similar studies.
- Finally, the project ends with some personal conclusions drawn from the findings observed during the conduct of the report, the annexes and its literature.

The aims with this report are:

- *Analyzing why marketing of iceberg lettuce bagged is the ideal choice for growth projects*
- *Developing technical skills required for implementation and economic viability*
- *Selecting what will be the strategy for its proper development.*

Currently, S.A.T. Peregrín 9989 is conducting different projects on various growth proposals in order to select which one best fits to their expectations. With this document the company will have a report that will allow it to include this possibility within the options that are been considered without requiring the corresponding study.

2. PRESENTATION OF THE COMPANY

S.A.T. 9989 Peregrin carries out its activity in the **Horticultural Sector**, specializing in the production, packaging and marketing of lettuce and garlic mainly but it also develops the production of radish at a much smaller scale. On the other hand, the owners of the company also have another closely related enterprise and through which they perform trading operations, aiming to provide to the key customers a set of products that S.A.T. 9989 Peregrin does not produce and which are demanded by thereof.

The sector in which S.A.T. 9989 Peregrín develops its activity has a wide importance in the Spanish economy and this is due to in the country are given climatic conditions and soil characteristics that promote horticultural production, which contributes around 50% of all agricultural production country. From the international point of view, it must be mentioned that the fruit and vegetables has a significant export orientation as it gets most of its income in foreign markets, reaching the level of exports around ten million tons per year and also the 60% of production is exported.

Focusing on one of the products with higher volume production in the company, we should mention that in the case of lettuce, Spain is the leading producer in Europe and one of the first in the world. Export is mainly directed to the European Union, Russia and Ukraine.

TECHNICAL SPECIFICATION

- NAME: S.A.T. 9989 Peregrín.
- PLACE OF BUSINESS: Nuestra Señora del Mar nº 4, Pulpí, Almería, Spain.
- DATE OF STABLISHMENT: 15/01/1977
- ACTIVITY: Production, packaging and marketing of vegetables
- TURNOVER: 50 million euro
- NUMBER OF EMPLOYEES: 302

ORGANIZATION OF THE COMPANY (ORGANIZATION CHART)

This company is catalogued in the Register as an Agrarian Transformation Society (SAT), which is a civil society-economic with the purpose of production, processing and marketing of agricultural, livestock or forestry, improvements in the rural areas, promotion and development of agriculture and provision of common services which serve this purpose.

The S.A.T. 9989 Peregrín is formed for 302 employees and the distribution of office staff takes place as shown in Annex 1.

COMPANY VALUES

S.A.T. 9989 Peregrín has a very important **Quality Policy** as well as strict, so periodically it performs extensive controls that have their start in the planting of the products, including the processes of collection and packaging. These efforts to provide the most exigent product have induced the company obtain several important quality certifications both nationally and internationally such as GLOBAL GAP, TESCO or BRC Certification body.

In terms of its **Trade Policy**, S.A.T. 9989 Peregrín focuses on differentiation based on the service offered to customers and quality. This is because the products sold by the company, lettuce, garlic, and other vegetables which are of generic consumption products which hinders their differentiation through the intrinsic characteristics of the product.

Differentiation made by the company is founded on two fundamental aspects:

- The first is the **Flexibility and Adaptability to Customers**, this is reflected in because the customers have the ability to make changes in their orders even at the last minute, with the assurance that if the truck is not out of the facilities yet these changes will take place and the customer will have the merchandise that

they really need. This distinction may seem "easy" but it is not because they are perishable products and the company cannot keep the product in stock and must thus perform many business operations in order to balance the products with customers in a very limited time period and without discarding the product.

- The second issue is the **Fidelity**, this feature of the company is appreciated especially at difficult times in the industry, in which due to a series of circumstances (weather, business, labour, etc..) the product becomes scarce among providers, thereby impacting in turn into higher prices. In these situations, S.A.T. 9989 Peregrín makes an effort to respond to customer requests that have been there throughout all the season, providing as much as possible and do so at prices significantly below those that exist right now in the market, not letting succumbing by unusual or new customers who offer much higher prices. These actions cause the company ceases to make big profits but on the other hand, is one of the most added values of the company, considered and appreciated by all their customers since most of them once they start to do business with S.A.T. 9989 Peregrín they do not change of supplier.

3. REASONS FOR THE CHOICE OF THE PRODUCT

Once the decision of basing my project on the implementation of a new product in S.A.T 9989 Peregrín was made, I should consider what the right product was. At this point I studied various possibilities, for example, I posed the implementation of any products which are currently required from our clients and are supplied by trading operations, so perhaps it might be more profitable if we carry out our own production. However, I finally decided to introduce a processing plant that would allow the production and marketing of IV Range lettuce. Initially the product to launch it would be iceberg lettuce cut, washed and bagged but this project is done with broad vision and the idea of going to expand the sort of IV Range products to offer.

There are several reasons for choosing the IV Range. First, the consumption of IV Range products is immersed in a continuous process of growth, the demand for product of this category is increasingly higher, not only by the final consumer at the point of sale, but also is increasing its demand in restaurant chains or HORECA (Hotels, Restaurant and Catering) channel distribution in general. Another fact to consider is that the demand growth is being developed in many countries, favoring the possibility of exportation and minimizing the damage that the economic crisis in which many countries in the European Union are immersed can cause, because it does not affect in the same degree to the various EU countries.

On the other hand, now a day, the IV Range is not a total new world for the company because for several years it has maintained several commercial relationships with companies engaged in this product category. During winter season S.A.T. 9989 Peregrín supply iceberg salad to various foreign companies, which are IV Range processors. These companies carry out the whole process from raw material arrives at its facilities until it is distributed to various retailers. These processes will be studied in later sections.

I also considered this IV Range possibility because within the commercial activity that the studied company performs, the most common is that from time to time incidents occur regard to the cultivation of the product because its proper development

and collection are influenced by many external factors and often unpredictable as for instance the weather. All this means that many times it is obtained a product that does not meet customer specifications for reasons as size, weight or appearance of lettuce. This is a problem for the company because the production cost would become an expense because the product cannot be used for sale. As companies engaged in the IV Range are much less exigent on product specifications, S.A.T 9989 Peregrín sends these salads to these companies and with that it is able to obtain almost any income from a product which in principle should be discarded despite the price is considerably smaller than for other customers of the company, which demand product by pieces and pay higher prices. This leads to the conclusion that the strategy that S.A.T. 9989 Peregrín followed on relations with customers engaged in IV Range is not profit but to minimize losses.

With the introduction of a salad processing plant within the company, S.A.T. 9989 Peregrín could further reduce losses or even turn a profit the lettuce that does not meet the specifications of other customers, since among other things, it would save the cost of transportation to England. On the other hand, the direction of the company should change its strategy which should contain this product category and they should devote a number of farms to cultivate specific lettuce varieties to IV Range and it would make the business more profitable.

4. MARKETING STRATEGY

4.1. CONSUMPTION OF IV RANGE.

Due to the characteristics of IV Range these products are more consumed in higher developed countries with a high purchasing power and also the consumption increases in urban areas. On the other hand, there are other aspects that also influence these data. In some societies much importance is given to proper alimentation, so the elaborated dishes are highly appreciated at the same time that valued unlike in societies as the British the point is the speed and convenience and they are used to eat at work some from a vending machine or a lunch precooked at home.

A medium American can consume up to 30 kilos of products made of IV Range, while the European average is 3 kilos per person per year. However, there are very substantial differences in Europe. In the UK reaches twelve kilos per person per year, France is ranked second and consumes half its neighbour, six kilos per person and year. Italy consumes about four. Other countries where the IV Range is well established, but apart from the above, are Belgium, Holland, Germany. In Spain this figure is set to 1 kilo and 1.5.

Regarding to the Eastern European countries, with economies increasingly better positioned, begin to have a great development in this segment aspect.

4.2. USUAL CONSUMER PROFILE.

These products have an added value and are oriented to customer with a higher purchasing power, this niche market occupies a large percentage of big cities, taking into account the social economic segmentation and these products are also oriented to HORECA, which require a product containing high quality, fresh, to provide greater comfort and speed and a daily provision.

There is also a large segment of the consumer that consists in schools where hundreds of thousands of students and which require a supply of these products.

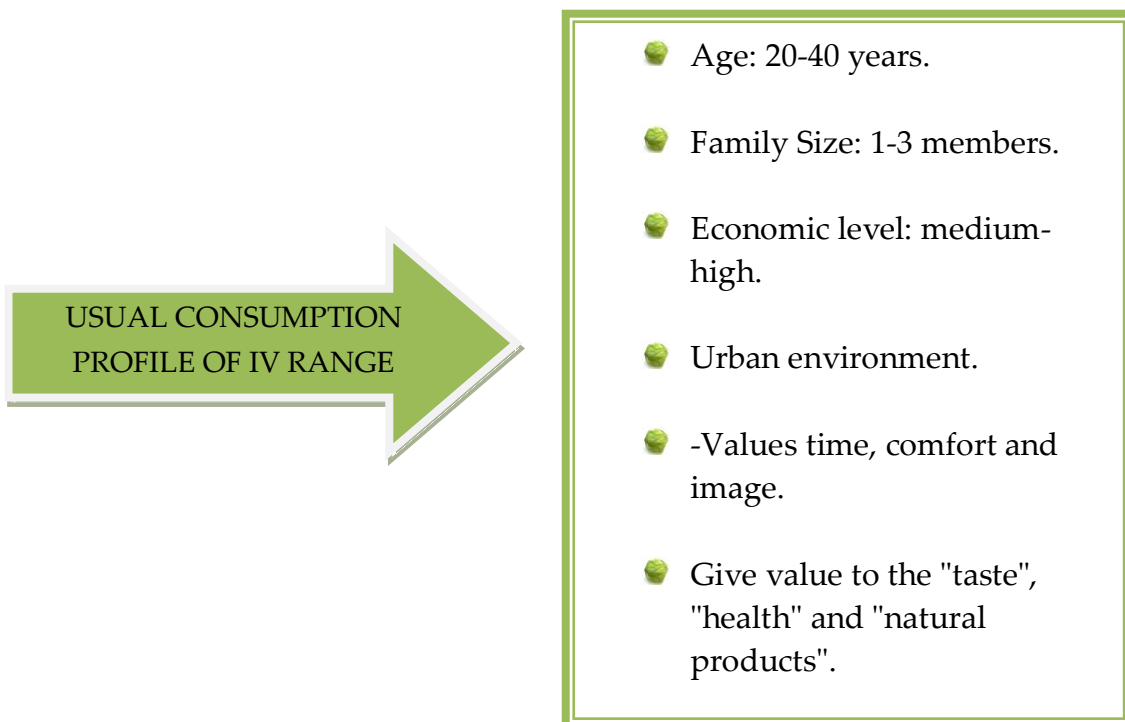

4.3.SWOT ANALYSIS

OPPORTUNITIES	THREATS
<ul style="list-style-type: none"> - The IV range sector presented the greatest prospects of the consumption of foods growth all around the world. - The new trends in the rhythm of life and the incursion of women in working life strengthen the sector of the IV Range. - Increase in the trend in consumption outside the home of fast food healthier (preponderance of fresh fruits and vegetables). - Recent official initiatives promoting the consumption of fresh fruit and vegetables "5 al día" on which S.A.T. 9989 Peregrín takes part. - Opening up of emerging markets in differentiated products as Southeast Asia and Eastern Europe. 	<ul style="list-style-type: none"> - In the sector of the IV Range competes with products already existing and well positioned. - Foreign Companies firmly consolidated in the global sector. - Increasing competition from third countries with access to external markets (rest of Europe, USA, Chile, Turkey, etc.). -Increased internal and external competition in productions which are sensitive to the competition by the elimination of tariffs.
STRENGTHS	WEAKNESS
<ul style="list-style-type: none"> - Long and respected export trajectory of the sector in Andalusia. - Existence of research groups at national universities that improve and develop products and processes for the sector of the IV Range. - Development of research specific to IV Range in centres of innovation and technology of Almeria (PITA). 	<ul style="list-style-type: none"> - Limited technological knowledge of the sector. Very young industry in Spain. - Industrial level in the field of the IV Range with a limited capacity to meet potential external demands. - Industrial capacity Insufficient to develop I+D+i of new products, formats, containers, adaptations, etc... - Low productive diversification and product range reduced.

4.4.COMPETITORS

KERNEL

The company KERNEL EXPORT SL is located in the town of Los Alcazares, Murcia. Its business is based on the production, packaging and distribution of fruit and vegetables to Europe.



The beginning of its activity took place in 1982 due to a split in the family business. Subsequently, in 1986 and 1995 various companies were formed with the goal of continuing with a proper development, but finally it is in 1996 when Kernel Export S.L. was born as Organization of Producers of Fruit and Vegetables number 577. In 1998 it was held the start-up of the main module of prepared salads factory and in the successive years and until today, Kernel Export S.L has made continuous enlargements in its facilities of IV Range products.

Kernel has a production capacity of around 25000 tonnes of product per year, a turnover of more than 60 million euros and 12 IV Range processing lines.

FLORETTE

The company was initially founded in 1983 as a family business. Four years later, the birth of the brand "Florette" occurred in 1987 and opened its plant in Lessay. During all these years, Florette has enjoyed a rapid and stable growth, even to acquire several of its main Spanish competitors as Vega Mayor, Tallo Verde and Sogesol in 2001, 2008 and 2013 respectively, becoming the first of them in the Spanish subsidiary responsible for managing the markets of Spain and Portugal.



The Florette Group is composed of 12 production plants in five different countries allowing them to get over 91.000 tonnes of finished product, all that gets a turnover of 402 million of euros.

VERDIFRESH

The company Verdifresh is established in Ribarroja in the province of Valencia. It was founded in the year 2000 and it aimed was to satisfy the demand of the Mercadona supermarket chain and it is its unic customer. In addition to different types of salads, which is the main product of the company, Verdifresh supply other packed food like chard and spinach, soups, vegetables, steamed potatoes and various plug-ins until 28 references.



Verdifresh has four production plants located in Ribarroja (Valencia), Antequera (Málaga), Aranda de Duero (Burgos) and Granadilla de Abona (Tenerife), which employ more than 450 workers. The turnover reached by Verdifresh in 2011 was 83,2 million euros.

BABY FRESH

Babyfresh is the trademark of the company Primaflor. This company was founded January 20th, 1976 with the aim of cultivate all kinds of plants products, both owned as foreign farms through leasing as well as performing all treatments and handling until their marketing in the domestic market and abroad.



Primaflor is a company of great importance and significance within the Spanish business tected also features with the distinctive ENTERPRISES TOP 50,000, which is given to major Spanish companies by turnover.

NATURE'S WAY FOOD



Nature's way food is one of the leading companies in England dedicated to the fresh products, supplying bagged salads and prepared fruit. This company was created in 1994 and for years it has enjoyed a rapid growth reaching today three different processing stores in West Sussex on the South coast, two of them are specialized in the processing of sheets and the remaining is dedicated to the fruit processing.

Nature's way food is supplier of many and very important supermarket and restaurant chains such as Mc Donals, Asda, Tesco, Costa Caffee... and its trade-mark is "Lasting leaf"

In 2010, Nature's way food came to achieve annual revenues of more than 86 million euros with a profit rate that exceeded the 9.4 million euros.

KANES FOOD

This company produces a wide range of washed and ready to eat salads, prepared vegetables and dressings, fresh salads and sauce.

The logo for Kanes Foods consists of the words "Kanes Foods" in a white, sans-serif font, centered within a solid green rectangular box.

Kanes Foods Ltd. was founded in 1989 and is established in Evesham, United Kingdom. From the moment of its foundation and until today it has enjoyed stable development that has allowed it to get a revenue of \$125 mill in the last year.

The last two British companies mentioned are companies that currently are customers of S.A.T. 9989 Peregrin. In every beginning of year it reaches a trade agreement through which it acquires the commitment to supply certain trucks of products throughout the season to a certain fixed price.

DOLE FOOD

DOLE FOOD COMPANY is a company that has its origin in Hawaii, country where was founded in 1851. This company is the first worldwide producer and distributor of quality fresh fruits and vegetables and is the leading producer in eco-friendly banana. Its seat is located in California, USA.



Dole has more than 60 centers of transformation, maturation, conditioning and distribution and the largest maritime fleet of refrigerated containers in the world, with 25 ships and about 14 200 reefers. In the year 2009, its global sales surpassed the 6.8 billion of dollars.

These are some of the most important competitors of IV Range however normally these competitors do not provide products that contain inside only iceberg lettuce but they combine different types of lettuce or even in many cases offer fully prepared salads consisting of different types of lettuce and several other ingredients ranging from carrot to cubes of cheese or toasted bread. The containers which offer only iceberg just ready to eat often belong to “white brand” of the supermarket.



4.5. COMPETITORS PRICES

The following table shows the price, brand and weight of iceberg lettuce bags that can be found in some of the most important selling points of the countries which the company aims to reach during the first stage of the project.













SPAIN			
	QUANTITY	PRICE	BRAND
	200gr	0,85€	Carrefour
	350gr	1,45€	
	200gr	0,84€	Auchan
	200gr	0,89€	
	250gr	1,00€	Aliada
	250gr	1,00€	Condis
	200gr	0,87€	Eroski
	200gr	0,87€	Verdifresh
	200gr	1,09€	Eroski
ENGLAND			
	QUANTITY	PRICE	BRAND
	100gr	1£ (1,19€)	Sainsbury`s
	2x80gr	1,30£ (1,54€)	
	260gr	1£ (1,19€)	Tesco
	260gr	1£ (1,19€)	Asda
	2x110gr	1£ (1,19€)	
		300gr	1,50£ (1,78€)
	200gr	1,30£ (1,54€)	Lasting Leaf
	300gr	1,50£ (1,78€)	Waitrose
FRANCE			
	QUANTITY	PRICE	BRAND
	300gr	1,64€	Carrefour
	300gr	1'32€	Auchan
	450gr	1,88€	
	GERMANY		
	QUANTITY	PRICE	BRAND
	200gr	1,29€	EDEKA
	250gr	1,99€	

Table 1.Competitors prices

Taking into account these data, the strategy of the company will be different for each country:

- As the table shows in *Spain* the most common format contains 200gr/bag and the average price is around 0,90€, so that initially in this market S.A.T. 9989 Peregrín will adapt the offered quantities from other competitors and it will offer 200gr/bag and the final price should not be less than 0,85€ unless the product is on promotion.
- In *England* there are different formats and even some of these formats consist of two separate containers. The table shows how there are higher differences in prices among the distributors of this country, but this company will begin launching formats compounds of 250gr/bag and the price will be around 1,1€
- In *France* formats contain a greater amount of product and its price ranges between 1,64 and 1,88 €. The strategy of the company would be to incorporate 300gr/bag and the price will be around 1,40€
- In *Germany* I could not find more information because of the language difficulties but this supermarket is very representative there because it is the largest German supermarket corporation. Here the quantity is similar to the Spanish market but the prices are something more high, so the iceberg lettuce bags will have 200gr and the price will be near to 1,25€.

These price for each country are just a estimation, they depend on some factor as for example the rapel of the distributor, so they could be change according to the market demands.

As it was mentioned in the previous point, all these data have a common characteristic and it is that the prepared salad bags which contain just iceberg lettuce, in most cases are found only within the range of products belonging to the distributor's brand,.

4.6. POSITIONING STRATEGY

In marketing, positioning is called the image that occupies a brand, product, service or company in the consumer's mind. This positioning is built from the consumer perception about this particular brand individually from the competition and it develops a strategy that aims to bring a brand, company or product from its current image to the desired image.



When it performs a positioning strategy, it should consider the following factors:

- The *differentiation* is an important factor in the positioning. Position yourself next to rest does not habitually offer any advantage.
- The best position is one that is *not imitable*, if competitors can imitate in a short term, it will lose the opportunity to differentiate.
- The positioning of the product has to provide *benefits* that are relevant to the consumer.
- It is important to enable the *integration* of the positioning strategy within communication of the company.
- The position it wants to achieve must be *profitable*.

In this case, S.A.T. 9989 Peregrín will continue with the positioning already fixed for the rest of their products, this is based on quality and good relationship with customer. It pretends to have presence above all in the largest supermarket chain because if you are within their, you have the possibility of being in more countries and increase the turnover. To get this aims the company usually establish very good relationship with costumer and help them when they are in troubles, this is a differentiation not easy to imitate since it is not material and not easy to get. On the other hand, quality is also very high and the prices are not so much.

In the next page there is a table with an evaluation of the different attributes of the product for the studied company and some of its main competitors. The attributes

considered are which consumers attach greater importance at the time of the purchase, such as:

- **Brand:** the brand is a name, term, sign, symbol, design or a combination of them that is assigned to a product in order to identify and distinguish it from other products on the market, but also it has other utilities or functions such as distinctive function, quality and origin indication and advertising. Because all them the brand is one of the most important and taken into account attributes when costumer make the decision of which product to choose.
- **Packaging:** the packaging of a product is used to contain, protect, handle, distribute and present products. The design of this container can also influence the decision of the costumer to buy one product or another, either because it draws more attention or because they inspire more confidence.
- **Quality:** the quality involves the ability to meet the wishes of consumers. The quality of a product depends on how it responds to the preferences of customers, so it is said that quality is fitness for use. Specifically for this product the quality differences are no really appreciable only seeing the bag but when the costumer has already bought the product previously.
- **Taste:** the taste is the sensation that produces food or other substances in taste. Regarding the lettuce it can find significant differences between the different brands, this attribute is a strength of the product that S.A.T. 9989 Peregrín offers.



BRAND	3	6	9	5	7
CONTAINER	6	5	8	7	8
QUALITY	9	6	9	8	7
TASTE	8	7	8	7	7
TOTAL	26	24	34	27	29

Table 2.Evaluation of the attributes

4.7. INSERTION STRATEGY

The selection of the countries and potential customers where the enterprise initially will launch the newly attached to the list of references IV Range salad will be based on known market to the company and where it currently has a presence. The decision of starting from these markets with these certain characteristics was made in order to benefit from the advantages that offers a consolidated customers with which the company develops an usual business and they have a strong mutual trust, thanks to these contacts there is a chance that it would be interesting to take advantage. The relationship of the S.A.T. 9989 Peregrín commercial department staff with the provisioning manager of major customers, in many cases shifts the labour barrier getting to create a personal connection, which could be helpful in carrying out the arduous task of launching a new product.

On the other hand, another added value to start introducing the new product through companies that are already part of our client portfolio is that there already is a solid distribution channel through which to reach the final consumer.

The process will be as follows in this order:

- Once selected the countries that are part of the initial target launch and through which companies will perform this process, one person within the sales department will be chosen, person that each client trust more and with the client may feel more comfortable dealing with.
- In next step, the employee of S.A.T. 9989 Peregrín will inform the customer about the new launch and its features and benefits.
- Later, it will be offered to customers free delivery of a particular amount of product, communicating what would be the wholesale price so they can mark up the price that they think fit and they can evaluate the acceptance of the product by the customer. The product may make with the company brand or



with the customer's private brand, as it is the case with many of the products supplied by S.A.T. 9989 Peregrín now a day.

- Once customers know the new reference, the next action will be use different marketing strategies to IV Range lettuce will still be present in the customer orders.

There are many commercial strategies to encourage customers to continue demanding a product. Practical examples of this can consist in to carry out promotions in combination with the references which are part of the common customer orders, namely, to perform a reduction of X% of a specific reference for a certain period of time with the commitment by the customer to sue X amount of the new product in each order. Another interesting measure would be the realization of promotions in different retails, where a stewardess would give to try the product to the client and would explain some of the advantages of this particular brand. Going beyond it could contact one of current programs of cooking and to make a deal for the cook advertises the product.

Thanks to methods like the above and some others, the launched product will acquire a greater presence on the shelves of retails and will become more known to the customer what will be giving more supplier power to the company and a greater margin of manoeuvre that will allow it the possibility of consolidating this reference within the range of offered products by the company and even positioned in different places and customers.

4.8. TARGET COUNTRIES

At this point, it process to mention the countries that the company considers as a target for the early inclusion of the new product on the market and why they have been chosen.

One of the selected countries for this initial phase is *Spain* and this is due to a thorough knowledge of the market and its characteristics and because it is in this area where S.A.T. 9989 Peregrín has most of its customers. The largest customer of this

company in terms of volume of purchase is Eroski Distribution S.A. and S.A.T. 9989 Peregrín is its unique supplier of lettuce in pieces, so a way to start the implementation of the IV Range is, as it was defined in the previous section, offering to the responsible for provisioning/purchasing the ability to insert this new reference in their shelves. This process will take place gradually; while there will be a continuous analysis of the customer acceptance level.

Thanks to the used of this hypermarkets and supermarkets chain, S.A.T. 9989 Peregrín may reach the whole country, which will allow to discover on which areas of the country there is a higher sales volume and analyze why to take action where necessary.

Another target country in the early step of IV Range is *Germany*. This country has been framed in the group of "pioneers", firstly, because it is a place where there is one of the highest consumption rate of IV Range in Europe and secondly because, as happened in the case of Spain, in Germany the enterprise also has a client that is widespread throughout the country, this is LIDL and probably it would be willing to test with this new reference, since S.A.T. 9989 Peregrín does not only supply lettuce but it also supplies garlic so they know well performance, dependability and service that the company offers. However, LIDL is a supermarket chain that not only works nationally but it has facilities in many countries of Europe so there is the possibility of thanks to this client the firm could position in several countries where there is also a high consumption of this type of product, such as in Austria, Belgium or others.

On the other hand, another customer like LILD that could offer the possibility of achieve more European countries is Zenalco. It is a subsidiary of the Auchan group (from Auchan supermarket) dedicated to the export of Spanish fruit and vegetable products; it is a client who is considered among the most faithful of the company. At the moment, Zenalco makes important orders of different types of lettuce to supply establishments in France, although gradually it is also increasing its trust and positioning the product of S.A.T. 9989 Peregrín in other countries such as Italy or Poland.

The studied firm has also a great confidence from one of the largest food distributors in *England* as Sainsbury's. Currently it supplies to Sainsbury's significant amounts of different types of garlic. It is true that there are different people in charge of buy lettuce and garlic within this client but there is also an opportunity to take advantage, since if the company could get in touch with the person who runs the lettuce supply it will have the option of one of his colleagues gives its good references on S.A.T. 9989 Peregrín products and service.

5. OPERATION STRATEGY

5.1.IV RANGE

Salunkhe and Desai (1991) defined a IV Range foods as "those fruits and vegetables processed to increase its functionality without changing appreciably its original properties." More commonly it is defined as clean fresh fruits and vegetables, cut and packaged to retain their natural properties and are ready to be consumed. Such products are generally packaged in modified atmosphere packaging and require to be retained at low temperatures (2 and 4 ° C), showing a lifetime between 7 and 10 days (and Peppelenbos Gorris 1999).

In order to obtain IV Range food, products must go through a series of processes:

- Collection of the raw material.
- Selection.
- Wash.
- Processing.
- Packaging.
- Labelling.
- Cold storage at a low temperature.
- Sales and distribution.

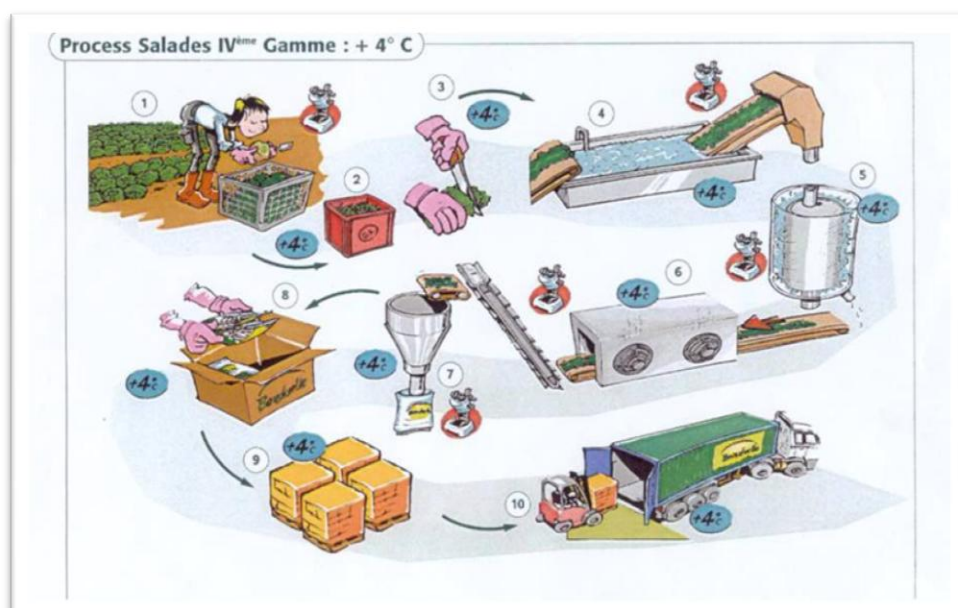

The first time that Spain had contact with IV Range products was in the 80s in Navarra and was spreading very quickly by the rest of the country, getting to play an important role in horticulture and reaching a turnover of about 200 million euro. This success is a direct result of the progress of the new consumer habits, which require ever more easy and quick products to prepare, but without sacrificing the properties of flavour, freshness and quality characteristics thereof. This led in 2005, the main producers of IV range set up an Association called Afhorla to respond the needs of the productive and economic activity.

The communities where IV Range has further development are in Valencia, Murcia, Catalonia and Andalusia and it is within these regions where several of the most important companies in the sector are set.

Regarding to IV Range products marketing channels, the most common it is the distribution to alimentation while a quarter of them is aimed at HORECA channel, which is increasing the familiarity with this category of products thanks to the enormous benefits that it provides of space, comfort or utilization.

Within the wide range of products offered by this IV Range the start product is specifically lettuce and lettuce in Iceberg mode. This is due, among other factors, to this type of lettuce are four variables that indicate their suitability for IV Range: Nassenov resistance (red aphid) Tip strength Burn (burnt edge) Bremia resistance, and large size and density.

5.2.PROCESS FLOW

The first step in the manufacturing process of fruit and vegetables IV Range begins in the field, where the raw material is grown under the best conditions so it has to meet the standards of food safety, quality and respect for the environment. About the harvesting of the plant material is made with the highest hygienic condition, when it acquires the appropriate colour and texture, and when the optimal maturity conditions are reached. Also the collection and selection of raw materials is an important step to obtain an attractive and high quality product for distribution in the market. To get high

quality products is required cultivate specific varieties with some controls and culture conditions determined, this would increase the use percentage of the land and therefore the overall product profitability will increase.

The process described below is based on a complete salad processing line which has a capacity of 800 kg/h. This processing line belongs to the German company Kronen and it was the one chosen to conduct this project.

Once the product has reached to the facility begins the transformation process which takes place in three distinct areas.

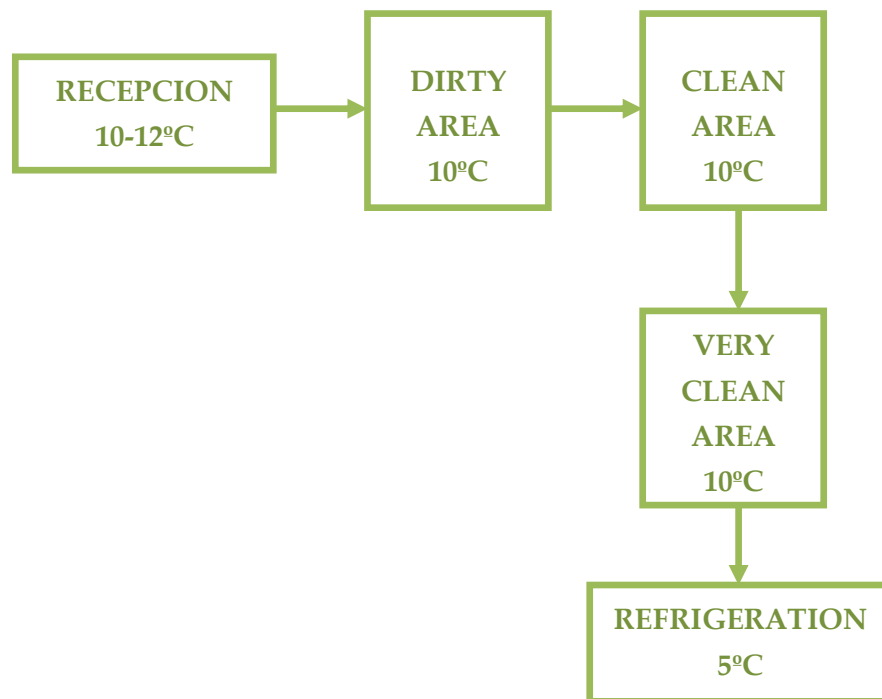

RECEPTION

First, the truck with the product is placed in the reception area where holds the product down and is introduced into the freezers to proceed with its cooled. In this reception area the appropriate temperature is between 10 and 12 ° C.

DIRTY AREA

In the next step, the staff charge of this work selects the product and the correct one is incorporated into the machinery where will take place the court. A common mistake is to think that within the IV Range product it can incorporate all those that have been discarded for manufacturing processes. This is a big mistake because if you incorporated product which is in not good condition at the end of the processing you will get a product unfit to be sold. On the contrary, as I mentioned in previous sections, if the product does not meet the specifications about size or weight but it is in optimal state it is perfect to be incorporated into the line.

During this step, other operators are responsible to dispose the lettuce zone that are not useful for the final product and then they cut it into four parts. The selection of the optimum salad area can have wastage between 20 to 70%. Once this task is done, the product is placed on the conveyor until it reaches the zone of cutting machine. Afterwards, the product is deposited again on a conveyor belt which moves it to the next processing zone.

CLEAN AREA

The following step of the process is the washing. At this stage the product dirtiness as ground dirt, mold or bacteria is removed. The washing and disinfecting of the IV Range products is performed with cold water at a temperature between 3 to 4°C. It is recommended using about 8 to 10 litres of water per kg of product processed. The water used must be checked periodically to see if its application is suitable or not.

For the disinfection it is used sodium hypochlorite (food use chlorine) at a concentration of 100 to 150 ppm. This disinfectant can be found in various formats (liquid, tablets ...).

In the washing process, there is a continuous bubbling of the water which made, on one hand, that the disinfectant is spread evenly throughout the water in the container and on the other hand, the already chopped lettuce is moved to the exit area in order to arrive the next phase where take place the rinsing. This phase has the aims to remove

the disinfectant that salad may have acquired in the previous step. The rinsing is done with only water and once it conclude the product is deposited on a new conveyor but this time its is not a conventional conveyor belt but a vacuum pump which allows removing the excess of humidity produced by washing.

The last step performed in the clean area is the spin, once the previous step is finished, the product is deposited in different containers that are introduced into the centrifuge machine where have effect a complete drying of lettuce to avoid the appearance of microorganisms that usually appear when the products have not been subject to proper drying. If we subject the product to a too quick drying it could also damage the material, so it must be done in a controlled manner. Lettuce particularly does not suffer a significant deterioration at this stage as can occur with other IV Range product such as chopped fruit.

VERY CLEAN ZONE

From the centrifuge some workmen are charge of the salad basket transportation to the very clean area where the packaging take place, there the product is introduced into the upper side of the machine and by pressing a button it goes falling in the relevant bags. In these bags there is the possibility of incorporating a mixture of gases that increase the life of the lettuce, it is known as modified atmosphere. The composition of gases commonly used in modified atmosphere are nitrogen, oxygen, carbon dioxide, although other gases are also used, such as argon, etc. The combination of gases to be used is based on the type of product, the packaging material and the storage temperature. Subsequently, the bags are sealed and transferred to the cooling zone.

REFRIGERATION

At this stage the product must remain at a maximum of 5°C. Ideally, the product goes to its destination the same day which has been made on reaching in the best possible condition and with the most days of life.

After completing the whole process it should take a sample of lettuce for the corresponding analysis in order to verify that effectively the batch of devices is in perfect condition for sale. Typically, companies that do not have a major magnitude or are being initiated into the category of the IV Range, perform these analyzes by outsourcing specialized laboratory services. An aspect which we must give special attention is the hygiene throughout this process. All plant and machinery must be focused on this factor and the process must carry out with maximum hygiene possible, taking into account even the smallest details, since the smallest crack can cause that the batch acquire a particle and it does not allow its commercialization. In later sections it is mentioned some of the important factors to maximizing hygiene.

5.3. IMPLEMENTATION DEVELOPMENT

In this section it precedes to breakdown all the necessary tools, utensils and facilities for the implementation of our new product.

5.3.1. MACHINERY

Earliest, we are going to start with the complete study of the selected production line for this first contact with the IV Range category product.

There are a lot of companies providing industrial food machinery (Marroda, Tutati, Kronen, Axel Lines & System, ...) that offer numerous models for the various stages of the salad processing and also for complete processing lines. Once consulted many of these companies, have studied the different technical characteristics of some products offered, the different prices for diverse models and taking into account the S.A T 9989 Peregrín needs, finally it was consider that the most suitable option was to acquire a complete salad processing line with a capacity of 800 kg/h. from the machinery company Kronen GmbH, one of the leading companies in the supply industrial machinery sector. Apart of this line, it is also necessary to acquire a packaging machine which will be purchased from the same company.

The line consists of the following machines:

- GS10 vegetable cutter.
- GEWA2600V PLUS washing.
- K50 or ECO Centrifuge.

One advantage of this salad processing line is that it offers great performance with minimal staff requirement.

GS10 Vegetable cutter.

The vegetables cutter GS10 is number one in worldwide sales. To cut salad, vegetables, herbs, meat, fish, sausages and it is possible to grate bread, cheese and various nuts. This machine offers a modern technology. It has a conveyor for feeding the product, thereby providing a continuous supply. It also has a pusher to handle the product in the proper position to move to the cutting section. The speed of the blades and the band are adjustable, it is also possible to continuously adjust the cutting thickness of 1 to 50 mm.

Products are transported carefully and are subject to the cutoff point ensuring a perfect quality cut. Newly developed materials improve the operating life of the components and make quick, easy and effective replacement. It only takes a few seconds to change the blades.

Its electronic control panel for ease to use allows digital adjustment of cut sizes. It can be introduced 100 individual programs, user definable, for the parameters of speed of the conveyor and the blade for a variety of products. All parts of the machine such as knives, guides, belts, tensioners, etc. are easily removed without any tool for cleaning purposes.



GEWA2600V PLUS Washing of vegetables

The GEWA2600V PLUS has a capacity of 100 to 600 kg/h. It washes care and delicately products such as lettuce, vegetables and fruits through a process of helical movement of water. This wash system guarantees to wash the product deeply, since entering to the wash tank; product joins the water spiral current (or whirlpool). It has an effective route of 15 to 30 metres even if the washer has a longitudinal dimension of 2,4 or 3,6 meters.

Advantages:

- Size: This model saves water consumption and the temperature of the tank is preserved for a long period, this works to keep low costs.
- Special washing: the spiral power created in the washing tank provides a distribution and complete separation of the product, resulting in a fine and effective washing.
- Submergence of the product: the helical system dips the product quickly and softly without the need to use other mechanisms for safe submersion.



The washed product is transported to the download section where water sprinklers are installed in the final section of discharge giving an additional shower wash to it, which helps to reduce or eliminate chlorine or other additives residues. This final shower can be considered as the wash step which we called rinse in previous sections. Next it is displaced through a small conveyor belt where takes place a small intake of excess of water.

All water used in the rinsing process will be guided directly to the main flow of the machine. In this way the water used in the wash tank is continually replaced with fresh water. Excess water is directly spilled to a specific area of the tank.

This model of washing machine is built in a modular way which allows that machines can be adapted to various conditions of production, for example by changing

the washing product discharge system: vibrating plate or conveyor band-mesh; or installing a new system of agitation.

In the washing tank the dirt is removed (like small stones and sand) and are separated from the current that carries the product. These remains are directed to a tub placed at the bottom of the wash tank. This will prevent that dirt comes into contact with the washing product once the process finishes.

K50 ECO Centrifuge

This model of centrifuge is used in the industry of salads, vegetables and Deli. K50-7ECO centrifuge offers settings of individual speeds rotation and rotation time adjustable freely, ensuring an optimal adaptation to the product.

The open, hygienic and entirely in stainless steel construction guarantees a quick and complete cleaning. This centrifuge has a silent but powerful engine that ensures little attrition and high durability.



UP 450I Packaging Machine



The chosen processing line does not include the packaging stage so this machine must be purchased additionally.

Within studied offers, as happened with the processing line, I consideres that the best option is the UP 450I model, also belonging to the company Kronen GmbH. It is of mechanical/pneumatic function and makes the process of giving form, fill and seal the bags. It has a smart remote control that adapts to any type of food "free-flow" (in bulk) product and other non-food products. The packaging is suitable for large production volumes (bag width maximum 900mm) and is able to pack 40bags/min.

Seal (for boost) allows material to be configured in various ways: Pillow (bags), with bottom of block or bellows bags (gusset). On the other hand, the digital control panel with detachable touch screen facilitates the displate of the machine operation and the use of it. The length of the bags can be defined freely. However the later sealing length is 450 mm and the maximum dimension that can be obtained by double seal is 900mm.

Accessories

For an optimum operation of the processing line, I considered appropriate to acquire, in additionally way, several accessories that will help to make the whole process with a greater fluency and accuracy.

The selected accessories are:

- Review table.
- Conveyor belt.
- Plastic Baskets.

The review table will be placed just before the automatic cutter. Here is where it will place the first step after the selection of the product and where workers are responsible for disposing the parts of lettuce that are not in an optimal state for processing. Later, these same operators



will introduce the selected portions already cut into four pieces in the cutter to perform the automatic cut into smaller fragments. This table includes four cutting boards and two slides for waste. In this case, the review table would have a length for four people.



The conveyor belt will be used to transport the product from the cutter to the washing machine. It is incorporate to the process with the aim of the process is performed automatically and is not required the intervention of any operator, thereby lowering production cost.

Once the water extraction process is finished by the washing machine, the product should be placed in a container for later introduction into the centrifuge machine.

These containers are plastic baskets that have a specific size and design for this type of storage. During the process it requires three baskets, one where the product washed is deposited, another that is inside the centrifuge conducting the process and another one empty waiting to be placed for washed product when the above process is completed. The plastic baskets are stackable, lightweight and manageable.

The Annex 2 shows the different specification of the main machinery.

5.3.2. SURFACE

To analyze the necessary surface for a IV Range processing room, the first and most important thing that must be done is to chose the machinery which will be installed. One that decision is made taking into account what is the most suitable for the production levels and expectations of the company it will proceed to estimate yhe surface.

In this type of fresh food processing it is very important that the flows of the product represent a straight line or at most one L-shaped, thus ensuring no contamination of the processed product to not cross at any time with the product yet "contaminated".

As quoted in previous sections, the selected machinery to implement the IV Range in S.A.T. 9989 Peregrín is an salad processing line: Trimming - cutting - washing up to 800 kg/h. plus a packaging machine and its related accessories necessary for the proper development of the process. It is in Annex 3 where it can see a plane that show how it will carry out the distribution of the different machines. This also allows to discover which is the measurements (in centimeters) of the complete processing line and where will be located the two cold store, both reception of raw product and the other one which will contain the ready-made product.

Thanks to specific software for the calculation of surfaces, I could know that the minimum estimated m² for the room should be 70.7m². In this calculation besides the

dimensions of the machinery, it has been considered other necessary aspects such as the required average area of work for each of the operators.

5.3.3. CONDITIONING OF THE PLANT

The conditioning of a fresh product processing room must have special attention, since the smallest detail can lead to a contamination of the product already made and accordingly to obtain a product not suitable for marketing.

In general way, the most suitable materials for construction are:

- Panels must be prefabricated with materials such as polystyrene and polyurethane.
- Characteristics of the flooring are as follows: waterproof to avoid that organic substances penetrate into the pavement; abrasion-resistant since the holes are an important focus of pollution; easy to clean and disinfect; non slip to avoid accidents and sloping to facilitate the evacuation of water and other fluids that can be found in the floor.
- Ceilings and walls will be constructed with easy to clean and disinfected materials to avoid contamination. In the area of processed, ceilings have a height no greater than 4 m.
- Ventilation of the shed has to be forced and air must be filtered in order to eliminate any contaminant particles. Handling and packaging rooms must be at a temperature below 12°C. It must have easy access to filters and other parts that need to be cleaned or replaced.
- Lighting systems must contain appropriate protection systems against possible breakage. The electrical system is composed of rush to overview of low voltage, overview of low voltage, circuits to secondary panels, secondary panels for control and protection and circuits to receivers.
- Cold stores for the storage of refrigerated products at 3-4°C temperature will be installed. There will be a separate refrigeration system with autonomous units

for different cameras. Also it will be cold in the process and packaging rooms at a temperature of 12 ° C or inferior.

- It will have potable hot and cold water for consumption, processing, handling and preparation of products and cleaning and washing facilities and machines.
- In this type of industry is issued a large amount of organic waste. At least there will be septic and bacterial filter.
- All the machines and equipment that come into contact with food, both raw, intermediate or finished product, shall be made with materials that in no case alter or contaminate with toxic substances to food and also it must allow easy cleaning and disinfection.

5.3.4. STAFF

The number of workers needed for the proper development of this activity is highly variable depending on the level of production that it wants to acquire. The different positions are as follows:

- Product selection: the ideal situation here is that two operators pick up the pieces of product from containers and deposit them in the trays of easy access to their colleagues that are in the review table, if the pieces are suitable for joining the process, or in disposal containers if they are not suitable.
- Review table: in this table can work from one to four operators. These operators perform the task of disposal areas of lettuce that they are not in good condition for processing, to cut the rest of the piece into four parts and deposit them in the tape that feeds the automatic cutter machine.
- Spin: when the centrifugation process concludes, an operator is responsible for extracting from this machine the basket with the dried product and place it at the agreed place in order to another partner in charge of the packaging phase collect it. He/she must also enter the basket which contain the newly washed product in the centrifuge machine and placed a new basket where washed product is deposited.

- Packaging: an operator will be responsible to introduce the already dry content on top of the packaging machine and at the same time press the corresponding button to allow the filling and sealing of the end bags.
- Controllers: it needs a minimum of two controllers which are in charge of the supervision of the entire process and resolve any incident that may occur.

This is the description of all the workstations however not necessarily all of them must be performed by different operators but if the level of production that is intended to obtain is not the maximum, then different position can be carried out by the same operator. Another fact to consider is that staff who performs any function within the process of IV Range must have specific training for this.

5.3.5. CONTAINERS

The containers which will be used for the marketing of this product in its initial stage will be filmed common bags that will count with an attractive design. These bags will contain between 200 and 250 gr/bag depending on the destination country and the preferences of the customer. As mentioned previously, into the bags it will introduce a certain mixture of gases to achieve, with this modified atmosphere, an increased of the life cycle of the product.

6. ECONOMIC ANALYSIS

The viability is a feature that guarantees that what is intended to do it can be done, namely, is feasible. The concept of profitability is a bit more complicated, since generally it involves social or economic considerations. That something is profitable means that it can do and also it wins with the change

The viability of a project can be approached from two points of view:

- Technical Feasibility: The technical solutions (machinery, equipment, facilities, and civil works) are affordable with the technology and available means, and also they are compatible with the nature of project.
- Economic Viability: The cost of the solutions is less than the economic benefit which gives the project. That is, the project at least return the money invested in it.

On the other hand, regarding to the economic profitability, although a project is economically viable, the benefits may be less than what an alternative investment would give. In this sense it is said that the project is not profitable.

Initial Investment

In regard to the completion of civil works, these expenses are not included in this heading because they have already been included in one previous, which was assigned to the expansion and modernization of facilities. In this project it was created spaces within the facility without having determined the finality of them in order to study various options and implement what were considered more suitable.

On the subject of *production equipment*, they involve an investment that amount to 229.200€, broken down as follows:

CONCEPT	UNIT COST
TRIMMING TABLE	2.000€
CUTTING MACHINE	42.000€
CONVEYOR BELT	2.500€
WASHING MACHINE	53.000€
CENTRIFUGE	34.000€
PACKAGING MACHINE	88.000€
GAS MIXER	6.700€
FOKS, TRAYS, BASKETS AND UTENSILS	3.500€
TOTAL	229.200€

Table 3. Production equipment investment.

Within the *facilities* it has taken into account its proper conditioning, considering a number of industrial plumbing needs, against fire installation, against intruder installation, air conditioning and ventilation installation, low voltage electrical installation, refrigeration, medium voltage network and processing centre. The total investment in this connection amounted to 187,000 €.

CONCEPT	COST
FACILITIES	187.000€
MACHINERY	229.200€
TOTAL	416.200€

Table 4. Total initial investment

This table shows that the initial investment amounts to 416.200€.

Operating expenses

To achieve an accurate estimation of recurrent costs of a project it should take into account every one of the associated costs with the development of the activity. Below are them:

Staff

This is the payment to employees, which already included the Social Security that belongs to the company.

WORKSTATION	COST
2. MANAGER	24.479,52€
10. WORKERS	91.527,60€
TOTAL	116.007,13€

Table 5. Staff cost

This estimation of the staff it has been done considering that the employees will work in two turns, so there will always be one manager and around five workers in each turn because some of them will do two of the tasks, as it was.

Raw materials

The raw material spending amounts to 528,000 €.

PRODUCT	TM (DAY)	PRICE/KG	TOTAL
ICEBERG	5	0,40	2.000€
TOTAL ANUAL			528.000€

Table 6. Raw material cost

Expedition

The expedition spending is estimated at 349.440€, it includes transparent film for packaging in boxes, cartons and required pallets.

Electric power

The generated spending in electricity consumption is estimated in 12.520,17€.

Potable water

The generated cost by drinking water consumption is estimated at 1.743€

Maintenance and repairs

The following table sets out the percentage to be allocated to general maintenance:

CONCEPT	INICIAL INVESMENT	%	FINAL INVESMENT
FACILITIES	187.000€	2%	3.740€
MACHINERY	229.200€	2%	4.584€
TOTAL			8.324€

Table 7. Maintenance cost

Miscellaneous and contingencies

It is estimated a proportion of 1% of the total expenditure and it amounts to 14.634,87€.

Total Operating Expenses

CONCEPT	QUANTITY
STAFF	116.007,13€
RAW MATERIAL	528.000€
CONTAINERS	349.440€
ENERGY	12.520,17€
POTABLE WATER	1.743€
MAINTENANCE	8.324€
CONTINGENCIES	10.160,34€
TOTAL	1.026.196,64€

Table 8. Total operating expenses

Estimated revenue

The revenues from the sale of the IV Range lettuce are show in the next table:

	BAGS	PRICE/BAG	TOTAL
ICEBERG SALAD	20.000	0,50€	10.000€
TOTAL ANUAL			2.640.000€

Table 9. Estimated revenue

The number of the bags is calculated taking into account the number of kilos per hour that the line will process, the product quantity that each bags will contain, a certain amount of product which will be discarded and the number of hour that it will work, considering the two turns, the workers' break time which will be higher than normal because the working conditions are under cold and the time that they use to prepare everything to start to work and to collect.

RESULTS

Once the expenditure and revenue of the project have been estimated, it process to the study of the obtained results through the known formulas Net Present Value (NPV) and Internal Rate of Return (IRR), which allow to make sure its viability :

The interpretation of these indices is:

NPV

- If the NPV is positive, the project is viable.
- If the NPV is zero, the project is at the limit of possibility.
- If the NPV is negative, the project is economically non-viable.

TIR

- If the corrected Internal Rate of Return (IRR) is greater than or equal to the interest rate (r), the project is profitable. That is, the project is at least as profitable as any alternative investment.
- If the corrected Internal Rate of Return (IRR) is less than the interest rate (r), the project is not profitable. In other words, there are better alternatives investments.

PARAMETER	VALUE
NPV	9.394.730,39
IRR	6,34

Table 10. Parameters

As the NPV is positive, the project is **VIABLE**.

As the IRR exceeds the discount rate ($r=10\%$), the project is **PROFITABLE**.

7. CONCLUSIONS

Previously, it was made a study about the launching of a new product in a company which currently is in a growth process. This project has evaluated many aspects both internal as external and the final findings are reflected in the SWOT analysis below:

STRENGTHS

- Sector Knowledge.
- Use of product which would be scrapped.
- Enough capacity within their facilities.
- Situation of growth and expansion in the company.
- Great potential client portfolio and good relationship with them.
- Ability to adapt the product to “white brand”.
- Great experience and knowledge about exportation.
- The project is viable.
- The project is profitable.

WEAKNESS

- Inexperience in IV Range.
- Absence of required machinery.
- Very basic offered product if it is compared to some already existing in the market.

OPORTUNITUIES

- Continuous increase of the demand in a generally way.
- Enlarged concern for healthy eating.
- Lack of production in Europe during the winter months.
- Change in the society trend.

THEATS

- Competitors with high experience in this category of products and well positioned.
- Difficult appreciable differentiation in the product.
- Important economic crisis that many of the targets countries are suffering.

I consider that there is an interesting opportunity of launching this product due little by little the society is changing and every one are more and more busy, so they look for comfort and speed, so the needed and demanded products are also changing. In order that if the company does not start this project now I am sure that it must do it later because a company like this, which is changing its strategy and wants to be more innovative has to go with the society trend if it wants to has a future prospection, as many of its competitor has already done. Therefore, the later it introduces this product, the bigger its competitors advantage will be.

Looking at the future, this is a project that has a wide vision for the future, inasmuch as it does not finish here but if it is correct developed and with a good acceptance by the client it will be incorporating new varieties which will adapt to the needs and



demands of different customers. At first, new products will be incorporated and they will hold back different kinds of lettuce or radishes, products that the company produces for itself, but later it will study the ways of collaboration to make alliances with other companies in the province which are specialized in growing different complementary products for salads, taking advantage of the synergies that such collaboration offers and further expanding the business vision.

On the other hands, other important aspect that makes me think this project could be the best option for the growth plans of the company is that, as it has been demonstrated in the economic analysis, it is not only viable but also profitable. It is true that is a very important project and it requires a high investment but in my opinion thanks to the fidelity of the clients and the way the commercial department works I

think that the risk is not too much high, the process can be faster o slower but the new product will finally be placed on the market with the desired positioning and it would help the company to make more profit and carry on with the others new projects.

8. ANNEXES

ANNEX 1. ORGANIZATION CHART

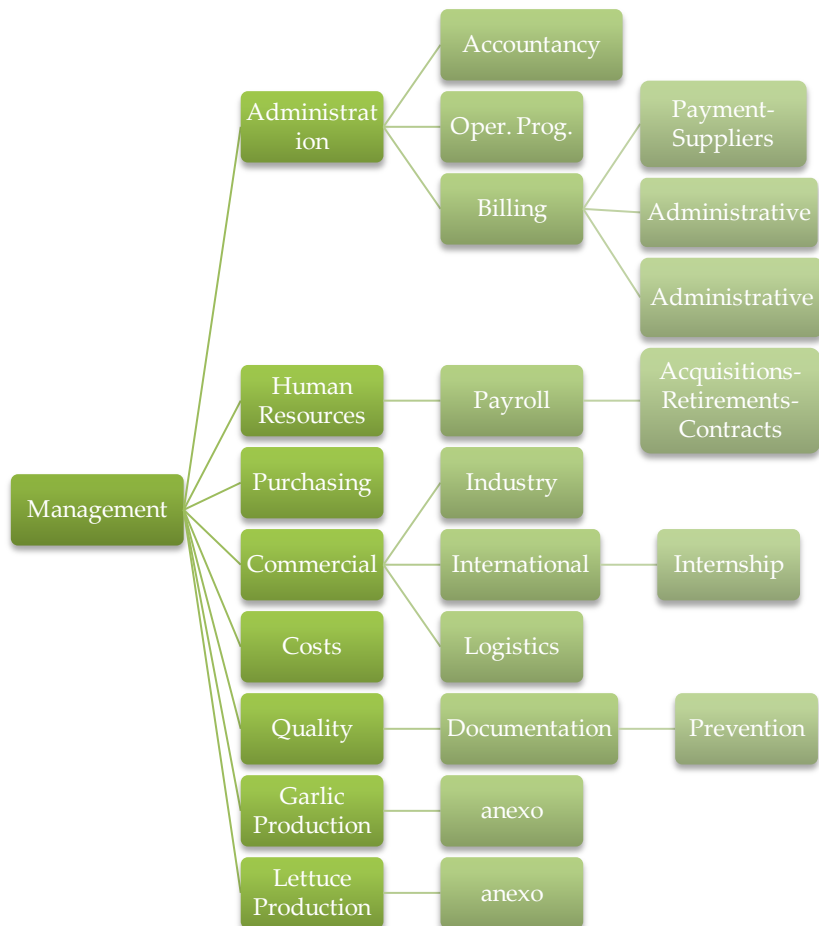

3. Centrifuge

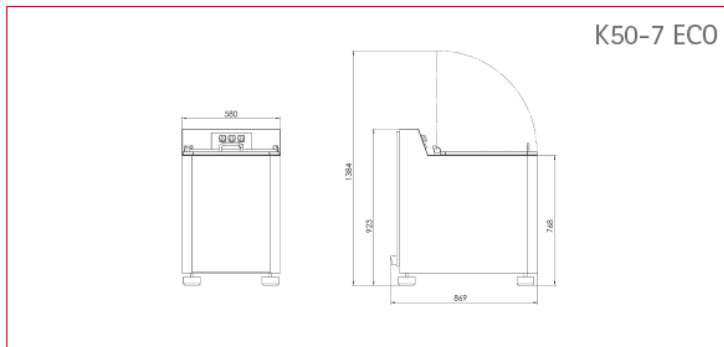

speed	250 - 850 r/min
basket volume	44 l
length	869 mm
width	580 mm
height	923 mm
weight	140 kg
infeed / feeding height	768 mm
discharge / outfeed height	768 mm
total power	0.75 kW
voltage	1~230 V N/PE
frequency	50 Hz
spin time	free adjustable

4. Packaging machine

Technical specifications UP			
	UP 300	UP 450	UP 650
Bag width pillow (min./max.)	75 - 300 mm	240 - 450 mm	350 - 650 mm
Bag width block bottom (min./max.)	50 x 25 - 200 x 100 mm	160 x 80 - 330 x 120 mm	100 x 250 - 210 x 440 mm
Maximum bag length	900 mm	900 mm	1350 mm
Film thickness heatseal material (PP)	25 - 130 micron	25 - 130 micron	40 - 200 micron
Maximum production speed heatseal (PP)	40 p/min	20 p/min	5 - 10 p/min
Maximum production speed Impulse (PE)	20 p/min	10 p/min	5 - 10 p/min
Maximum width film roll	640 mm	940 mm	1340 mm
Core diameter film roll	76 mm (3")	76 mm (3")	76 mm (3")
Outer diameter film roll	320 mm	320 mm	320 mm
Power	1000 Watt	1000 Watt	1500 Watt
Voltage	230 Volt / 50 Hz	230 Volt / 50 Hz	230 Volt / 50 Hz
Machine dimensions (H x W x L)	1250 x 760 x 810	1775 x 1060 x 1400 mm	2630 x 1650 x 1700 mm
Weight	200 kg	300 kg	500 kg
Options	Synchronisation with weighing/dosing systems, Frame for printing/coding unit, Photocell for printed film, Gasflushing, Vibration unit		

ANNEX 3. PLAN OF THE ROOM

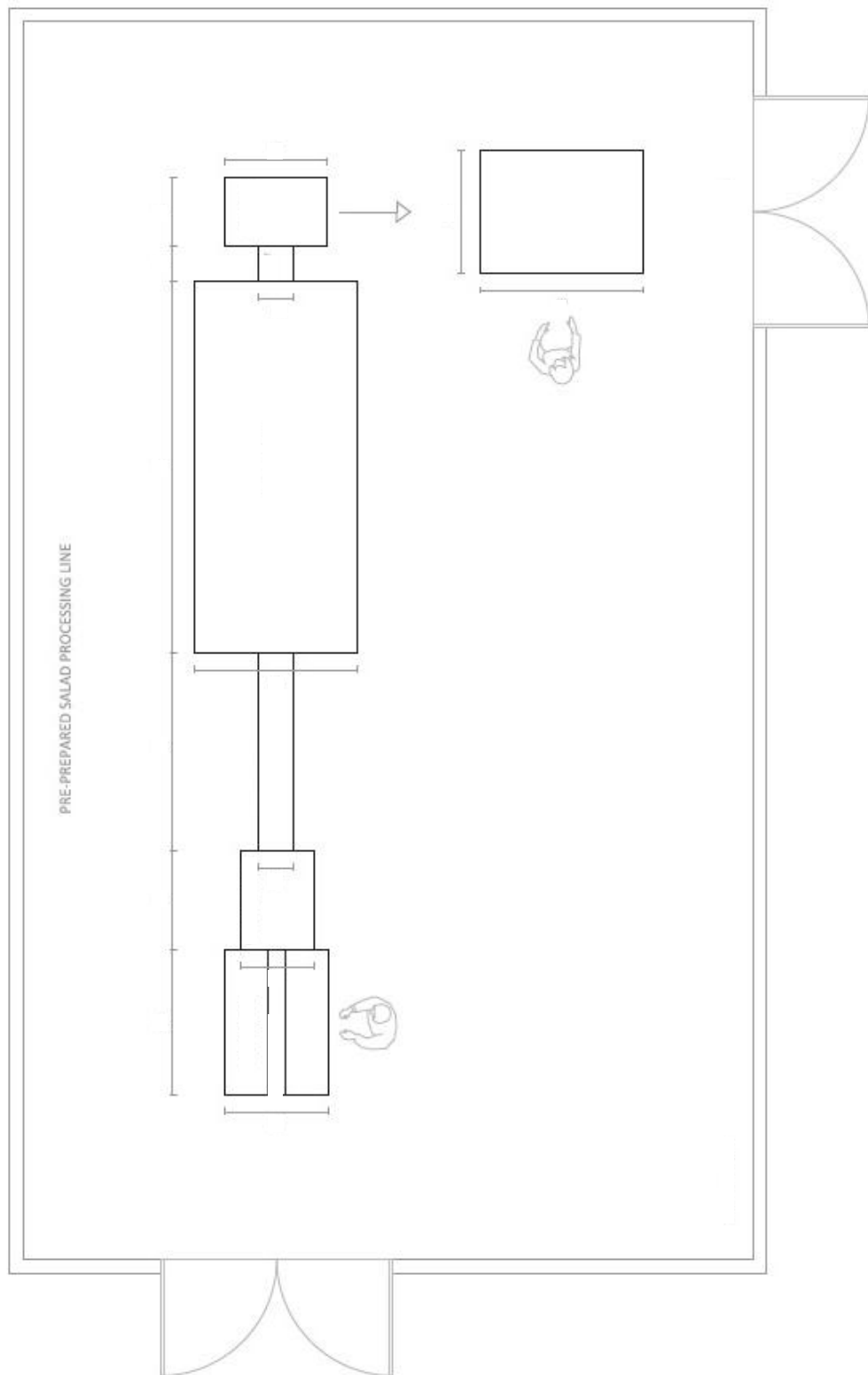

9. LITERATURE

BOOKS

1. Sheth, J. N.; Mittal, B. y Newman, B. I. (1999): Customer Behavior. Consumer Behavior and Beyond, Fort Worth: Dryden Press.
2. Sapag Schain, N. (2007): Evaluación de proyectos de inversión en la empresa (6ª Ed.). Prentice Hall.
3. Lambin, J.-J. (2004): Marketing Estratégico, Madrid: Esic Editorial.
4. Walker Jr., O. C.; Boyd Jr. H. W.; Mullins, J. & Larreché, J.-C. (2004): Marketing estratégico. Enfoque de toma de decisiones, Madrid: McGraw-Hill.
5. PENMAN, S.H. (2007): "Financial Statement Analysis and Security Valuation". McGraw-Hill. Singapore. (3th Edition).

WEB SITES

1. <http://www.aedemo.es>
2. http://www.kernelexport.es/kernel_export
3. <http://www.florette.es/group/key-figures>
4. <http://www.demaravilla.com/verdifresh-verduras-hortalizas-frescas-empaquetadas/>
5. <http://www.verdifresh.net/verdifresh.htm>
6. <http://www.europapress.es/economia/noticia-economia-empresas-verdifresh-proveedor-mercadona-incrementa-ventas-11-832-millones-20120601170017.html>
7. http://www.mercasa.es/files/multimedios/1318933366_pag_016-044_Cerdeno.pdf
8. http://www.ader.es/fileadmin/redactores/PUBLICACIONES/Estudios/Estudio_Benchmarking_sector_Agroalimentario.pdf
9. <http://www.worksmart.org.uk/company/company.php?id=5859487>
10. <http://www.ainiadisal.es/publico/docs/Prospecci%C3%B3n%20y%20tendencias%20IV%20gama.pdf>